



РиГ
Групп Ко



spirit of excellence



Sterilization Basket System

Sterilization Basket System

The optimum solution

The universal Sterilization Basket System from Richard Wolf provides safe and gentle accommodation for the valuable instrument set during sterilization, transport, and storage.

The universal basket concept allows virtually any basket configuration to be put together.



Top-heavy instruments are securely fixed with an open and a closed silicone holder.

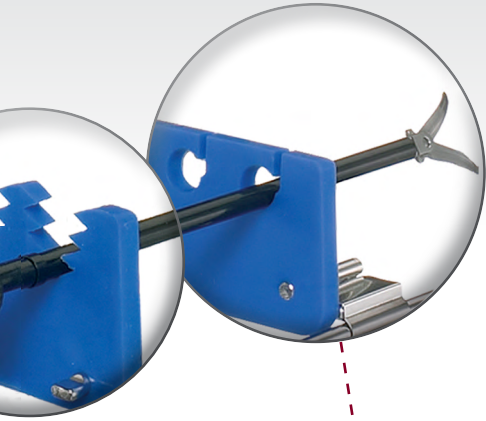

The patented double frame prevents the basket mesh from "becoming frayed" and hence causing injury to the user and damage to the sterilization packaging.

Our double frame therefore ensures maximum safety and a long service life.

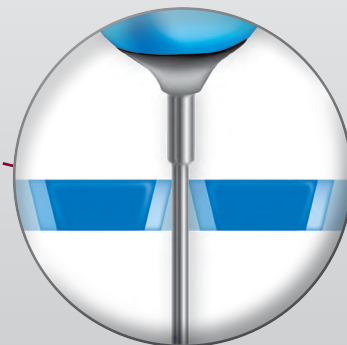
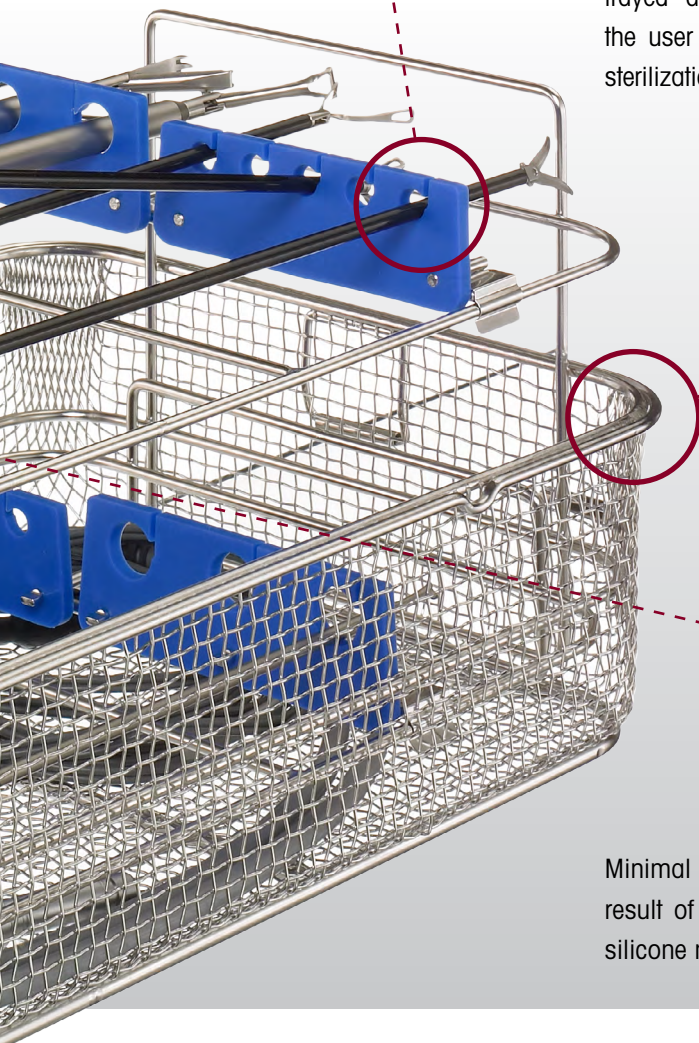
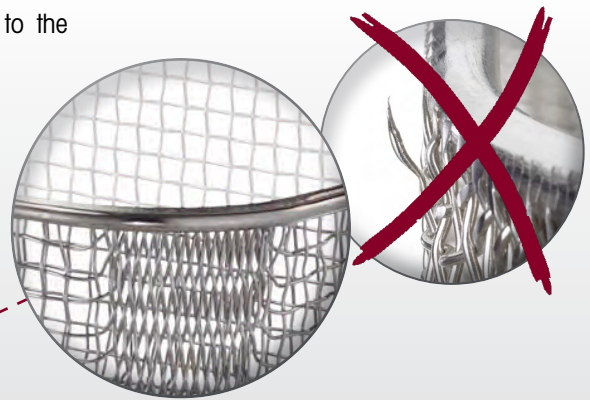

Minimal contact surface as a result of the special design of the silicone mounts.

Sterilization Basket System

Easy handling and configuration

System view with sterilization basket, high – Standard (8584.1202) and sterilization basket, high – long (8584.1302)

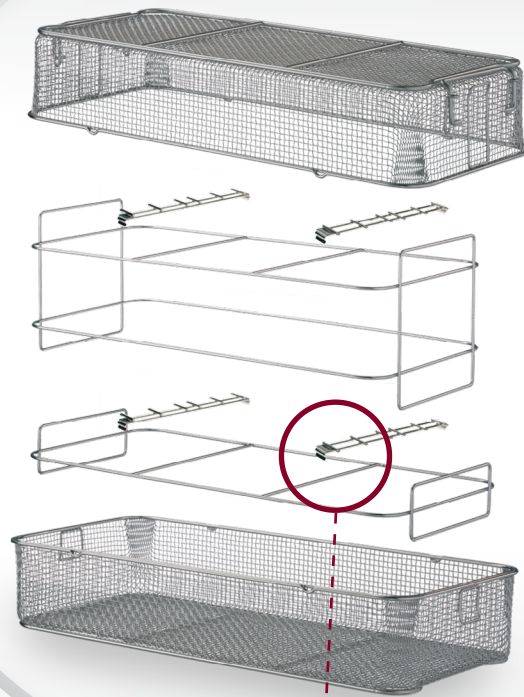

System view with sterilization basket, low – Standard (8584.1212) and sterilization basket, low – long (8584.1312)

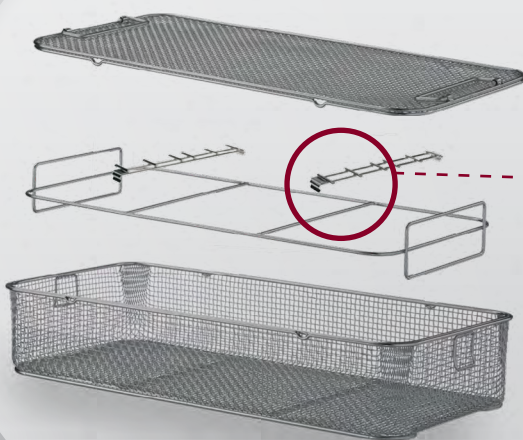

The silicone holders (blue) are based on the instrument diameter and should be ordered separately.











Sterilization Basket System



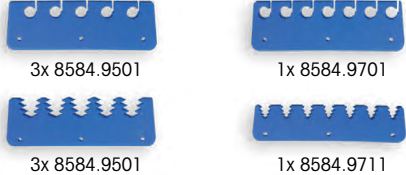

Ordering information

Picture	Designation	Type
	<p>Sterilization basket, high - Standard Dimensions (L x W x H): 530 x 250 x 200 mm consisting of: Basket lower part, instrument rack high and low, 4 support bars, basket lid high with spring lock and 2 handles</p>	8584.1202
	<p>Sterilization basket, low - Standard Dimensions (L x W x H): 530 x 250 x 108 mm consisting of: Basket lower part, instrument rack low, 2 support bars, basket lid flat with spring lock and 2 handles</p>	8584.1212
	<p>Sterilization basket, high - long Dimensions (L x W x H): 725 x 275 x 200 mm consisting of: Basket lower part, instrument rack low, 4 support bars, basket lid high with spring lock and 2 handles</p>	8584.1302
	<p>Sterilization basket, low - long Dimensions (L x W x H): 725 x 275 x 108 mm consisting of: Basket lower part, instrument rack flat, 2 support bars, basket lid flat with spring lock and 2 handles</p>	8584.1312
	<p>Sterilization basket, low Dimensions (L x W x H): 530 x 250 x 108 mm consisting of: Basket lower part, instrument rack low, 2 support bars, basket lid flat with spring lock and 2 handles, silicone mat "Large Diamond"</p>	85844001

Sterilization Basket System

Accessories

Picture	Designation	Type
	Support bar for silicone holder, double	8584.8203
	Silicone holder, closed, triple for instruments with \varnothing 8 mm – 14.5 mm	8584.9201
	Silicone holder, open, triple for instruments with \varnothing 8 mm – 14.5 mm	8584.9211
	Silicone holder, closed, for up to 5 items for instruments with \varnothing 1 mm - 7.5 mm	8584.9501
	Silicone holder, open, for up to 5 items for instruments with \varnothing 1 mm - 7.5 mm	8584.9511
	Silicone holder, closed, for up to 7 items for instruments with \varnothing 1 mm - 7.5 mm	8584.9701
	Silicone holder, open, for up to 7 items for instruments with \varnothing 1 mm - 7.5 mm	8584.9711
	Silicone stop plate Ensures the axial position of instruments with smaller diameters	85849005
 <p>3x 8584.9501 1x 8584.9701</p> <p>3x 8584.9501 1x 8584.9711</p>	Starting Set silicone holder for urology / arthroscopy consisting of: 3x 8584.9501, 3x 8584.9511, 1x 8584.9701, 1x 8584.9711	8584.9001
 <p>3x 8584.9501 1x 8584.9201</p> <p>3x 8584.9501 1x 8584.9211</p>	Starting Set silicone holder for laparoscopy / surgery / gynecology consisting of: 3x 8584.9501, 3x 8584.9511, 1x 8584.9201, 1x 8584.9211	8584.9002

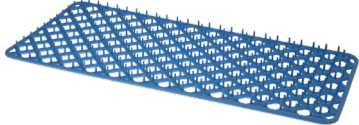
Picture	Designation	Type
	<p>System small part basket Dimensions (w x h x d): 121 x 35 x 121 mm</p>	8584.3003
	<p>Locking pin e.g. for fixation of handles Pack of 2</p>	8584.8205
	<p>Set of fixation brackets consisting of: O-ring set, 2x angle bracket, 1x allen wrench</p>	85848210
	<p>O-ring set (replacement part) consisting of: 1x O-ring 90 x 3 mm, 1x O-ring 116 x 3 mm</p>	74002311
	<p>Silicone mat "Large Diamond" Dimensions (w x h x d): 500 x 18 x 226 mm</p>	85843010

Reprocessing cycle



spirit of excellence



Specifications subject to change without notice.

Официальный дистрибьютор
и сервисный центр Richard Wolf

www.rgggroup-co.com
info@rgggroup-co.com

8 (812) 271 15 10
[@rig_group_co](https://www.instagram.com/rig_group_co)

г. Санкт-Петербург
ул. Кирочная 22, оф. 11