

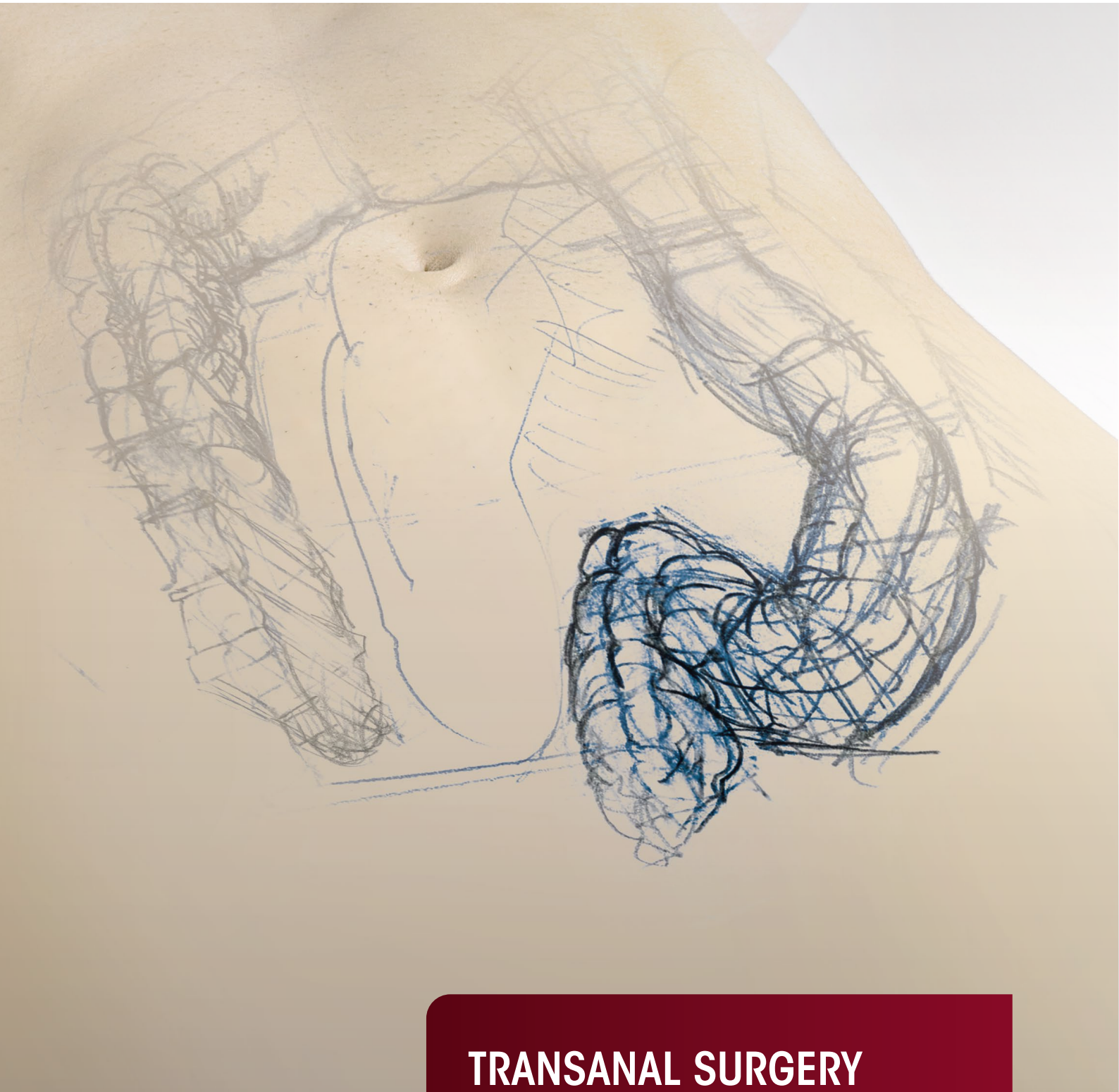

РиГ
Групп Ко



spirit of excellence



TRANSANAL SURGERY

TRANSANAL SURGERY

1

BASIC SET

2

TEM SYSTEM/STEREO AND DOCUMENTATION TELESCOPE

3

SUPPORT ARM SYSTEM

4

TEM INSTRUMENT SET

5

ACCESSORIES FOR TEM COMBINATION SYSTEM 2232

6

HF CONNECTION CABLE

Note:

The TEM pumps/devices combination system is no longer available as of May 2021.
The following related instruments are still available to existing customers.

BASIC TEM SET

TRANSANAL ENDOSCOPIC SURGERY

Product	Product no	Quantity	Catalog/Section
PANOVIEW stereo endoscope 50° Ø 13.8 mm SL 259 mm	884080	1	TEM/system
TEM basic part	8840.20	1	TEM/system
TEM tube bndl	8840.021	1	TEM/system
TEM tube bndl	8840.041	1	TEM/system
Adapter with observation window	8840.25	1	TEM/system
Working insert for TEM	8840.241	1	TEM/system
Silicone sealing insert	8840.242	1	TEM/system
Sealing caps			
Sealing cap capacity 2.4–3.4 mm, red-orange (PACK= 10 PCS)	89.01	1	TEM/system
Sealing cap capacity 3.4–5.1 mm, sky-blue (PACK= 10 PCS)	89.02	1	TEM/system
Sealing cap capacity 5.1–6.0 mm, light gray (PACK= 10 PCS)	89.03	1	TEM/system
Sealing cap capacity 4–6 mm, red (PACK= 10 PCS)	89.141	1	TEM/system
Sealing cap capacity 7.5–8.5 mm, blue (PACK= 10 PCS)	89.161	1	TEM/system
Sealing cap capacity 13.0–13.8 mm, gray (PACK= 10 PCS)	89.10	1	TEM/system
HF suction tube TEM Ø 5.6 mm WL 305 mm	8840.731	1	TEM/instrument set
HF knife Ø 4.5 mm WL 433 mm, right	8840.711	1	TEM/instrument set
HF knife Ø 4.5 mm WL 433 mm, left	8840.712	1	TEM/instrument set
ERAGONmodular TEM grasping forceps mono Ø 5 mm bndl			
angled downward and curved to the right	83946217	1	TEM/instrument set
angled downward and curved to the left	83946227	1	TEM/instrument set
curved to the right	83946237	1	TEM/instrument set
curved to the left	83946247	1	TEM/instrument set
Metzenbaum scissors mono Ø 5 mm bndl	83940417	1	TEM/instrument set
Needle holder Ø 5 mm, angled downward	8840.605	1	TEM/instrument set
Titanium clip for TEM, PACK= 10 units (6 PCS)	4840764	1	TEM/instrument set

STEREO AND DOCUMENTATION TELESCOPE

TEM SYSTEM

2





product design award
2010

HD AUTOCLAVE

	Direction of view	SL	TL	Ø	Product no.
<p>PANOVIEW Stereo endoscope 50° Ø 13.8 mm SL 259 mm</p> <p>with direct stereo and lateral documentation eyepiece, with irrigation channel</p>	50°	259 mm	410 mm	13.8 mm	884080

Recommended accessories		Product no.
<p>Perforated basket for stereo telescope inner dimensions (W x H x D): 451 x 130 x 189 mm, outer dimensions (W x H x D): 477 x 139 x 196 mm</p>		38010
<p>Fiber light cable bndl consisting of: Fiber light cable Ø 5 mm TL 2.3 m (80655023), projector-side adapter (8095.07), and endoscope-side adapter (809509)</p>	Ø 5.0 mm, 2.3 m long	806650231
<p>Fusion Fiber light cable bndl consisting of: Fiber light cable Ø 5 mm TL 2.3 m (80655023), projector-side adapter (8095.07), and endoscope-side adapter (809509)</p>	Ø 5.0 mm, 2.3 m long	806550231

i123 | Subject to modifications. Please note that some products may not be available in all countries. Please always take note of the information that is provided with the product. For more detailed information, please consult with your contact partner or directly with Richard Wolf GmbH.

ALTERNATIVES

TO STEREO AND DOCUMENTATION TELESCOPE 884080

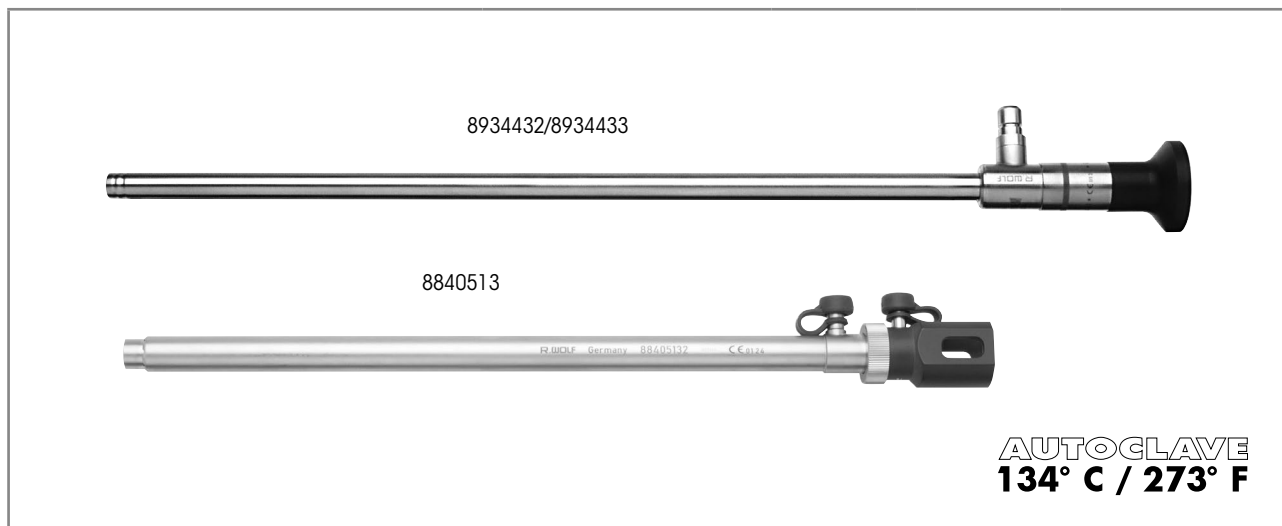

	Direction of view	WL	TL	Ø	Product no.
PANOVIEW Telescope 30° Ø 10 mm WL 307 mm	30°	307 mm	375 mm	10 mm	8934.432
PANOVIEW Telescope 50° Ø 10 mm WL 310 mm	50°	310 mm	375 mm	10 mm	8934.433
also:					
Telescope cover tube bndl	consisting of: TEM inner tube Ø 11.5 mm WL 282 mm (88405131) TEM outer tube Ø 14 mm WL 272 mm (88405132) Tube with Luer-Lock connector Ø 4 mm (886.01) Tube with Luer-Lock connector (886.00)				8840513

Recommended accessories	Product no.
Perf. basket for standard telescope 2	inner dimensions (W x H x D): 454 x 52 x 40 mm, outer dimensions (W x H x D): 481 x 54 x 59 mm 38016
Fiber lightcable bndl consisting of: Fiber light cable Ø 5 mm TL 2.3 m (80665023), projector-side adapter (8095.07), and endoscope-side adapter (809509)	Ø 5.0 mm, 2.3 m long 806650231
Fusion Fiber light cable bndl consisting of: Fiber light cable Ø 5 mm TL 2.3 m (80655023), projector-side adapter (8095.07), and endoscope-side adapter (809509)	Ø 5.0 mm, 2.3 m long 806550231

TEM INSTRUMENT SET

PROCTOSCOPE TUBES

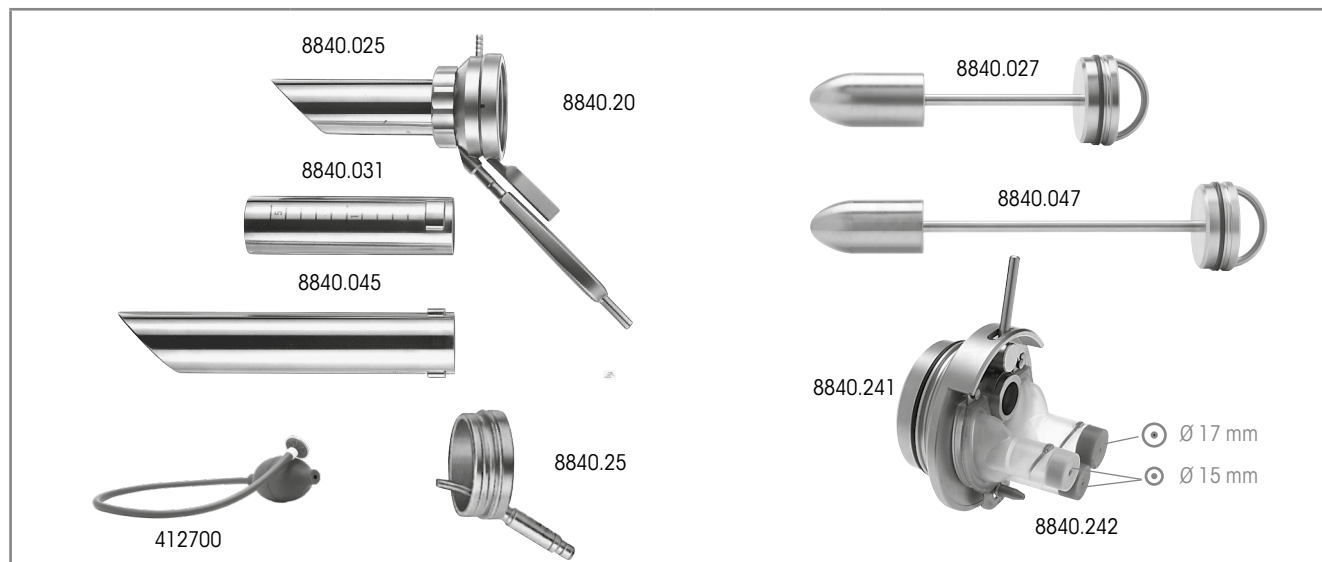

	TEM obturator Ø 36 mm WL 175 mm 8840.027	TEM obturator Ø 36 mm WL 255 mm 8840.047	Product no.
TEM tube bndl consisting of: TEM tube Ø 40 mm WL 137 mm (8840.025), TEM obturator Ø 36 mm WL 175 mm (8840.027)	•		8840.021
TEM tube bndl consisting of: TEM tube Ø 40 mm WL 137 mm (8840.031), TEM obturator Ø 36 mm WL 175 mm (8840.027)	•		8840.0311
TEM tube bndl consisting of: TEM tube Ø 40 mm WL 217 mm (8840.045), TEM obturator Ø 36 mm WL 255 mm (8840.047)		•	8840.041
TEM basic part			8840.20
Adapter with observation window and illumination insert for basic part 8840.20			8840.25
Working insert for TEM bndl consisting of:	Working insert for TEM (8840.241) Silicone sealing insert (8840.242) Sealing cap capacity 2.4–3.4 mm, red-orange (89.01) Sealing cap capacity 3.4–5.1 mm, sky-blue (89.02) Sealing cap capacity 5.1–6.0 mm, light gray (89.03) Sealing cap capacity 4–6 mm, red (89.141) Sealing cap capacity 7.5–8.5 mm, blue (89.161) Sealing cap capacity 13.0–13.8 mm, gray (89.10)		8840.2411
Hand blower sterile (PACK= 5 PCS) Hand blower with disposable filter Ø 49 mm, TL 567 mm			412700

1123 | Subject to modifications. Please note that some products may not be available in all countries. Please always take note of the information that is provided with the product. For more detailed information, please consult with your contact partner or directly with Richard Wolf GmbH.

TEM INSTRUMENT SET

PROCTOSCOPE TUBES

Spare parts	Product no.
Silicone sealing insert (PACK= 3 PCS) with 3 valve ports, (2 valve ports for auxiliary instruments up to 6 mm), (1 valve port for auxiliary instruments from 6 to 11 mm)	8840.242
Sealing cap capacity 2.4–3.4 mm , red-orange (PACK= 10 PCS)	89.01
Sealing cap capacity 3.4–5.1 mm , sky-blue (PACK= 10 PCS)	89.02
Sealing cap capacity 5.1–6.0 mm , light gray (PACK= 10 PCS)	89.03
Sealing cap capacity 4–6 mm , red (PACK= 10 PCS)	89.141
Sealing cap capacity 7.5–8.5 mm , blue (PACK= 10 PCS)	89.161
Sealing cap capacity 13.0–13.8 mm , gray (PACK= 10 PCS)	89.10

U-SHAPED SUPPORT ARM





		Product no.
U-shaped support arm for TEM with clamping prism	reusable	8840.9721
Also required:		
Clamp socket insulated	for attachment to the operating table (standard rail), reusable	88409722

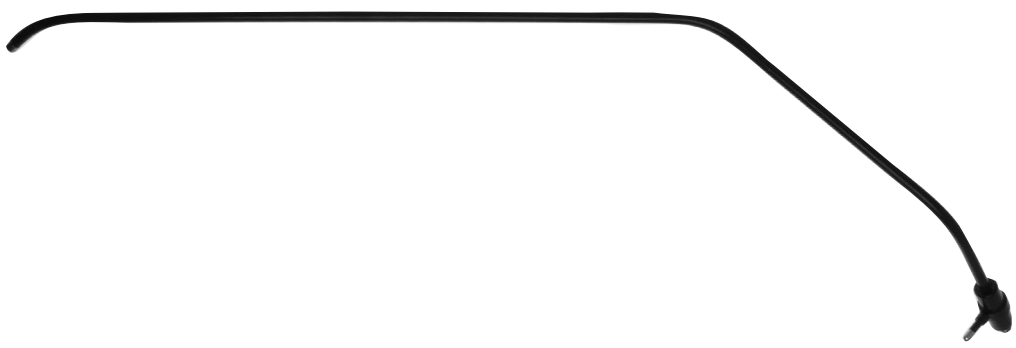

1123 | Subject to modifications. Please note that some products may not be available in all countries. Please always take note of the information that is provided with the product. For more detailed information, please consult with your contact partner or directly with Richard Wolf GmbH.

HF SUCTION TUBE / HF KNIFE



		Ø	WL	Product no.
 curved	HF suction tube TEM Ø 5.6 mm WL 305 mm integrated HF electrode, capacity 3 mm	6 mm	305 mm	8840.731















with ceramic insulation		Ø	WL	Product no.
 curved	HF knife Ø 4.5 mm WL 433 mm for right-handed users	4.5 mm	433 mm	8840.711
 curved	HF knife Ø 4.5 mm WL 433 mm for left-handed users	4.5 mm	433 mm	8840.712

HF connection cable: see page TEM16

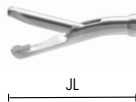
ERAGON modular

TEM GRASPING FORCEPS Ø 5.0 MM INSULATED







		Handle, axial			
 All jaw inserts and sheath tubes can also be combined with ERAGONaxial.					
		with lock	without lock, with HF connector	without lock, with HF connector	with lock, not rotatable
Rotatable knob	Product no.	83930082	83930083	83930084	83930085
	8988	•	•	•	•

Jaw insert		Sheath tube, Ø 5.0 mm, insulated		Handle, pistol-shaped	Complete instrument
 					• Jaw insert with sheath tube • Handle
	JL*	Product no.	8394933	83930074	Product no.
 angled downward and curved to the right single-action	28 mm	8394621	•	•	83946217
 angled downward and curved to the left single-action	28 mm	8394622	•	•	83946227
 curved to the right single-action	25mm	8394623	•	•	83946237

* JL = jaw length when jaw section closed (approximate measurements)
 HF connection cable: see page TEM16

ERAGON modular

TEM GRASPING FORCEPS / SCISSORS Ø 5.0 MM INSULATED







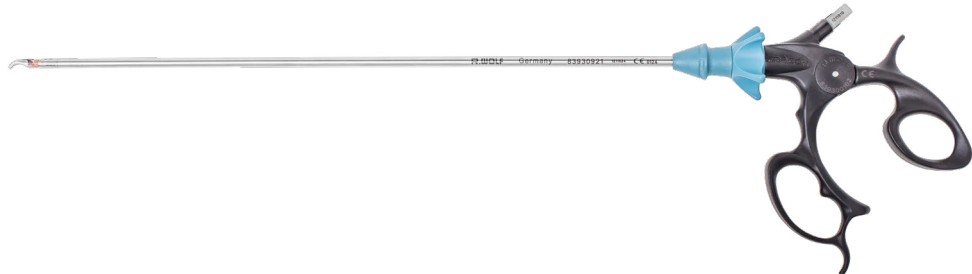

Jaw insert			Sheath tube, Ø 5.0 mm, insulated	Handle, pistol-shaped		Complete instrument • Jaw insert with sheath tube • Handle
			 WL 450 mm	 without lock, with HF, mono	 with lock, with HF, mono	
	JL*	Product no.	8394933	83930073	83930074	Product no.
TEM grasping forceps mono Ø 5 mm bndl  curved to the left single-action	25 mm	8394624	•		•	83946247
Metzenbaum scissors mono Ø 5 mm bndl  double-action	23 mm	8394.041	•	•		83940417

* JL = jaw length when jaw section closed (approximate measurements)
 HF connection cable: see page TEM16

1123 || Subject to modifications. Please note that some products may not be available in all countries. Please always take note of the information that is provided with the product. For more detailed information, please consult with your contact partner or directly with Richard Wolf GmbH.

ERAGON bipolar
MODULAR BIPOLAR INSTRUMENTS, 5.5 MM
ROTATABLE







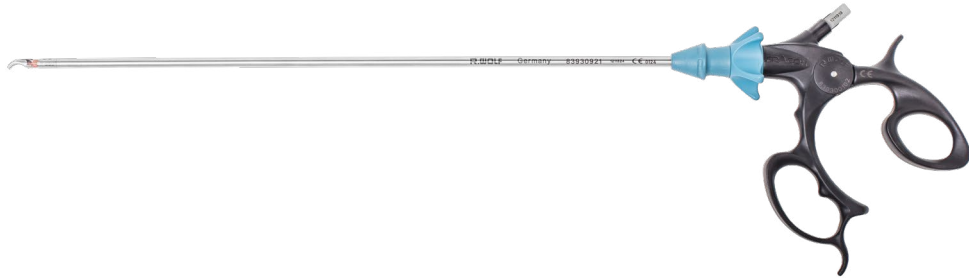

Jaw insert		Sheath tube Ø 5.5 mm		Handle, pistol-shaped, bipo	Complete instrument • Jaw insert • Sheath tube • Handle	
						
		SL 320 mm	SL 435 mm	rotatable		
	JL*	Product no.	83930921	82340024	839300102	Product no.
 Grasping forceps bipo Ø 5.5 mm bndl	21 mm	83930031	•		•	839300312
		839400310			•	839400312
 Maryland dissector bipo Ø 5.5 mm bndl	23 mm	83930032	•		•	839300322
		839400320			•	839400322
 Dolphin dissector bipo Ø 5.5 mm bndl	21 mm	83930033	•		•	839300332
		839400330			•	839400332
 Grasping forceps bipo Ø 5.5 mm bndl	23 mm	83930034	•		•	839300342
		839400340			•	839400342
 Preparation forceps bipo Ø 5.5 mm bndl	19 mm	83930035	•		•	839300352
		839400350			•	839400352

* JL = jaw length when jaw section closed (approximate measurements)
Bipolar connection cable: see page TEM17







ERAGON bipolar
MODULAR BIPOLAR INSTRUMENTS, 5.5 MM
ROTATABLE

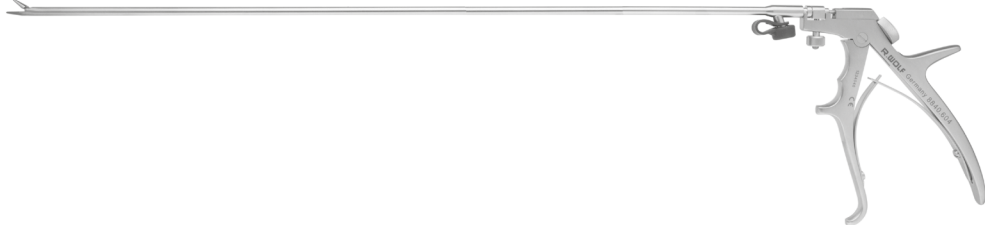

Jaw insert			Sheath tube Ø 5.5 mm		Handle, pistol-shaped, bipo	Complete instrument • Jaw insert • Sheath tube • Handle
						
			SL 320 mm	SL 435 mm	rotatable	
	JL*	Product no.	83930921	82340024	839300102	Product no.
 Sterilization forceps bipo Ø 5.5 mm bndl by Hasskamp	19 mm	83930036	•		•	839300362
 Münster grasping forceps bipo Ø 5.5 mm bndl	22 mm	83930037	•		•	839300372
		83930038	•		•	839300382
 Maryland dissector bipo Ø 5.5 mm bndl	15 mm	839400380		•	•	839400382
 Metzenbaum scissors bipo Ø 5.5 mm bndl	22 mm	83930041	•		•	839300412
		839400410		•		•

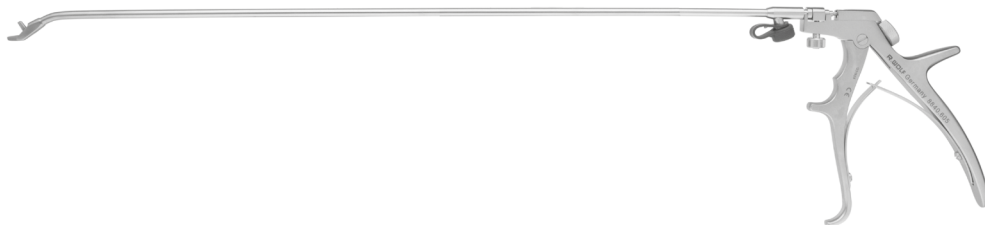
* JL = jaw length when jaw section closed (approximate measurements)
Bipolar connection cable: see page TEM17

NEEDLE HOLDER / TEM CLIP APPLICATOR / TITANIUM CLIP

				
with ceramic insulation		Ø	WL	Product no.
 straight	Needle holder Ø 5 mm	5 mm	400 mm	8840.604
				
with irrigation connector		Ø	WL	Product no.
 angled downward	Needle holder Ø 5 mm	5 mm	400 mm	8840.605
				
with irrigation tap		Ø	WL	Product no.
	TEM Clip applicator Ø 6 mm WL 435 mm	6 mm	435 mm	8840.762
Titanium clip		Ø	WL	Product no.
	Titanium clip for TEM sterile, PACK= 10 units of 6 pieces, incl. connecting part for clip	5 mm	405 mm	4840764

TEM COMBINATION SYSTEM 2232

ACCESSORIES

Spare parts	Product no.
High-pressure connection tube bndl consisting of: High-pressure connection tube L 1 m (8170.801) Open end wrench WS 30 (9500.016) with DIN connector	8170.8011
High-pressure connection tube L 1 m with PIN Index connector	8170.802
High-pressure connection tube L 1 m with ISO Index connector	8107.803
CO₂ connection tube L 5 m for centralized CO ₂ gas supply in accordance with DIN EN 13260-2/2004	8170.3111
TEM tube set sterile, disposable	4170.801
TEM tube set for Erbe instrument sterile, disposable	4170.804
Open end wrench WS 30	9500.016
Bottle holder for gas bottle Ø 80–90 mm for holding CO ₂ bottles	2221.951

HF CONNECTION CABLE MONO 8106xxx







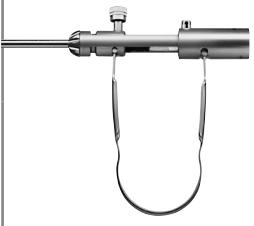

CONNECTION CABLE

6

Instrument connector	Device connector		Product no.
<p>WOLF Instruments/surgical generator</p> 		<p>HF connection cable mono L 3 m</p>	<p>8106.032</p>
	<p>Erbe (ACC/ICC)/BOWA (EU) R. Wolf HF surgical generator 400 kHz 2260002</p>	<p>HF connection cable mono L 5 m</p>	<p>8106.052</p>
		<p>HF connection cable mono L 3 m</p>	<p>8106.132</p>
	<p>Erbe (T series)</p>	<p>HF connection cable mono L 5 m</p>	<p>8106.152</p>
		<p>HF connection cable mono L 3 m</p>	<p>8106.031</p>
	<p>Martin (M-version)/Berchtold/Aesculap</p>	<p>HF connection cable mono L 5 m</p>	<p>8106.051</p>
<p>HF electrodes, monopolar</p> 		<p>HF connection cable mono L 3 m</p>	<p>8106.033</p>
<p>Bovie/Valleylab/Erbe (Int.)/BOWA (Int.) R. Wolf HF surgical generator 400 kHz 2260001</p>	<p>HF connection cable mono L 5 m</p>	<p>8106.053</p>	
	<p>HF connection cable mono L 3 m</p>	<p>8106.034</p>	
<p>BOWA (Int./EU) Eschmann and other devices with 4 mm plugs R. Wolf HF surgical generator 400 kHz 2260001/2260002</p>	<p>HF connection cable mono L 5 m</p>	<p>8106.054</p>	

1123 | Subject to modifications. Please note that some products may not be available in all countries. Please always take note of the information that is provided with the product. For more detailed information, please consult with your contact partner or directly with Richard Wolf GmbH.

HF BIPOLAR CONNECTION CABLE 8108XXX

Instrument connector	Device connector		Product no.
WOLF Bipolar forceps 	 Erbe (ACC/ICC/T)/BOWA (EU) R. Wolf HF surgical generator 400 kHz 2260001/2260002	HF connection cable bipo, L 3 m	8108.032
		HF connection cable bipo, L 5 m	8108.052
	 Martin (Int.)/ 2 pin Valleylab/BOWA (Int.) R. Wolf HF surgical generator 400 kHz 2260001/2260002	HF connection cable bipo, L 3 m	8108.033
		HF connection cable bipo, L 5 m	8108.053
	 WOLF/Martin (M-version)/Berchtold/ Aesculap	HF connection cable bipo, L 3 m	8108.031
		HF connection cable bipo, L 5 m	8108.051
Bipolar tweezers connection 	 Erbe (ACC/ICC/T)/BOWA (EU) R. Wolf HF surgical generator 400 kHz 2260001/2260002	HF connection cable bipo, L 3 m	8108.132
		HF connection cable bipo, L 5 m	8108.152
	 Martin (Int.)/ 2 pin Valleylab/BOWA (Int.) R. Wolf HF surgical generator 400 kHz 2260001/2260002	HF connection cable bipo, L 3 m	8108.133
		HF connection cable bipo, L 5 m	8108.153
	 Martin (m version)/Berchtold/ Aesculap	HF connection cable bipo, L 3 m	8108.131
		HF connection cable bipo, L 5 m	8108.151
 EMC Dolley	HF connection cable bipo, L 3 m	8108035	
	HF connection cable bipo, L 3 m	8108135	

1123 || Subject to modifications. Please note that some products may not be available in all countries. Please always take note of the information that is provided with the product. For more detailed information, please consult with your contact partner or directly with Richard Wolf GmbH.

